

37035

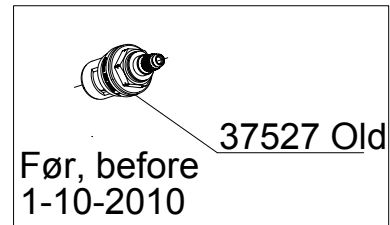

49240

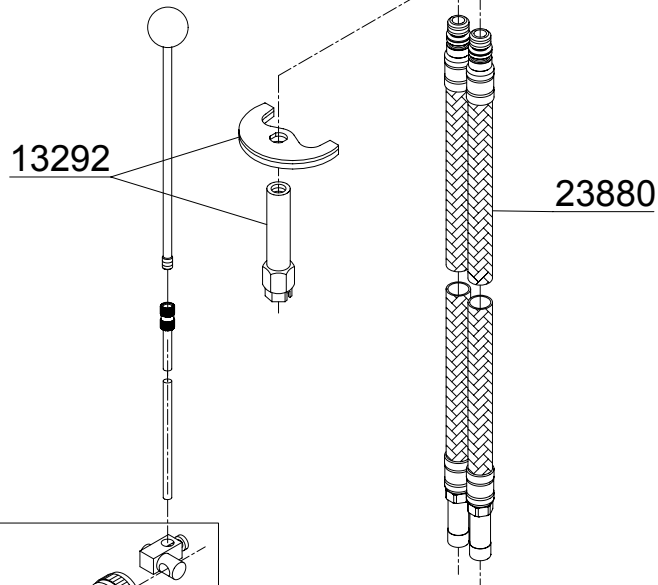
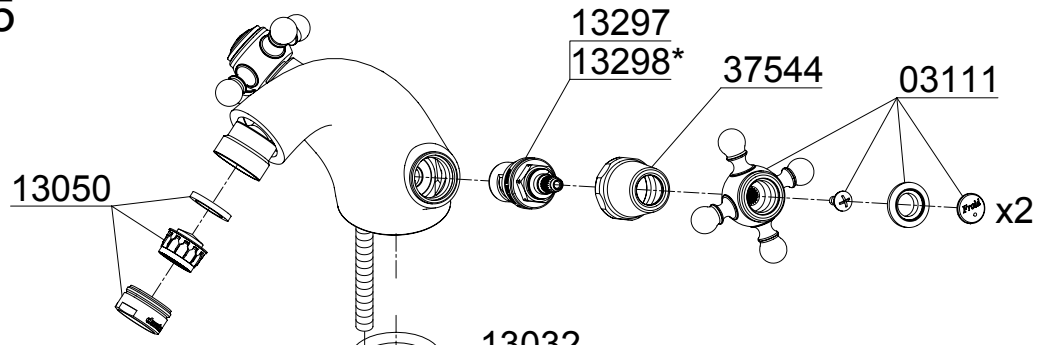