

72820
1-2-2011

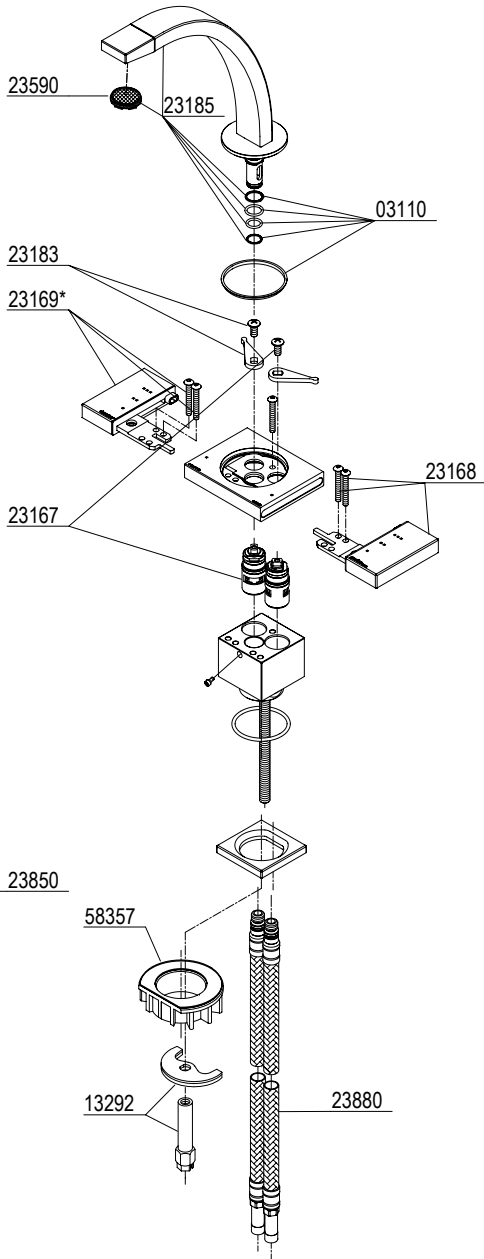

72820 (Old)

